

Ball Valves

for gas, water, heating, air-conditioning,
ventilation and sanitation systems



New generation of ball valves

The Austrian company HERZ Armaturen GmbH has for many years been producing ball valves for diverse applications in housing technology and industry. HERZ ball valves are manufactured on state-of-the-art production machines with precision and care on the main slovenian factory and are delivered to the clients in the whole Europe, Russia, Middle East until the Caucasus and Central Asia.

The new generation of ball valves is compact, light-weight and presents a comprehensive range of products for pipe installations.

The new construction design of ball valves comprise numerous improvements, which increase the quality of our products even further and enable a simple and quick assembly.

HERZ ball valves are not only suitable for use in heating, cooling and sanitary installations, but also for drinking water plants with regional

standards requiring special materials and product construction, in order to be able to fulfil the highest European standards. They are suitable for all non-aggressive media, such as water, compressed air, etc.).

FULL BORE BALL VALVES

HERZ ball valves do not require excessive circulating pump pressures, as they are always provided with maximum valve bore = full bore.



Spindle sealing: PTFE - teflon

Ball sealing: PTFE - teflon

Valve body: brass, manufactured in accordance with EN 12420, nickel-plated



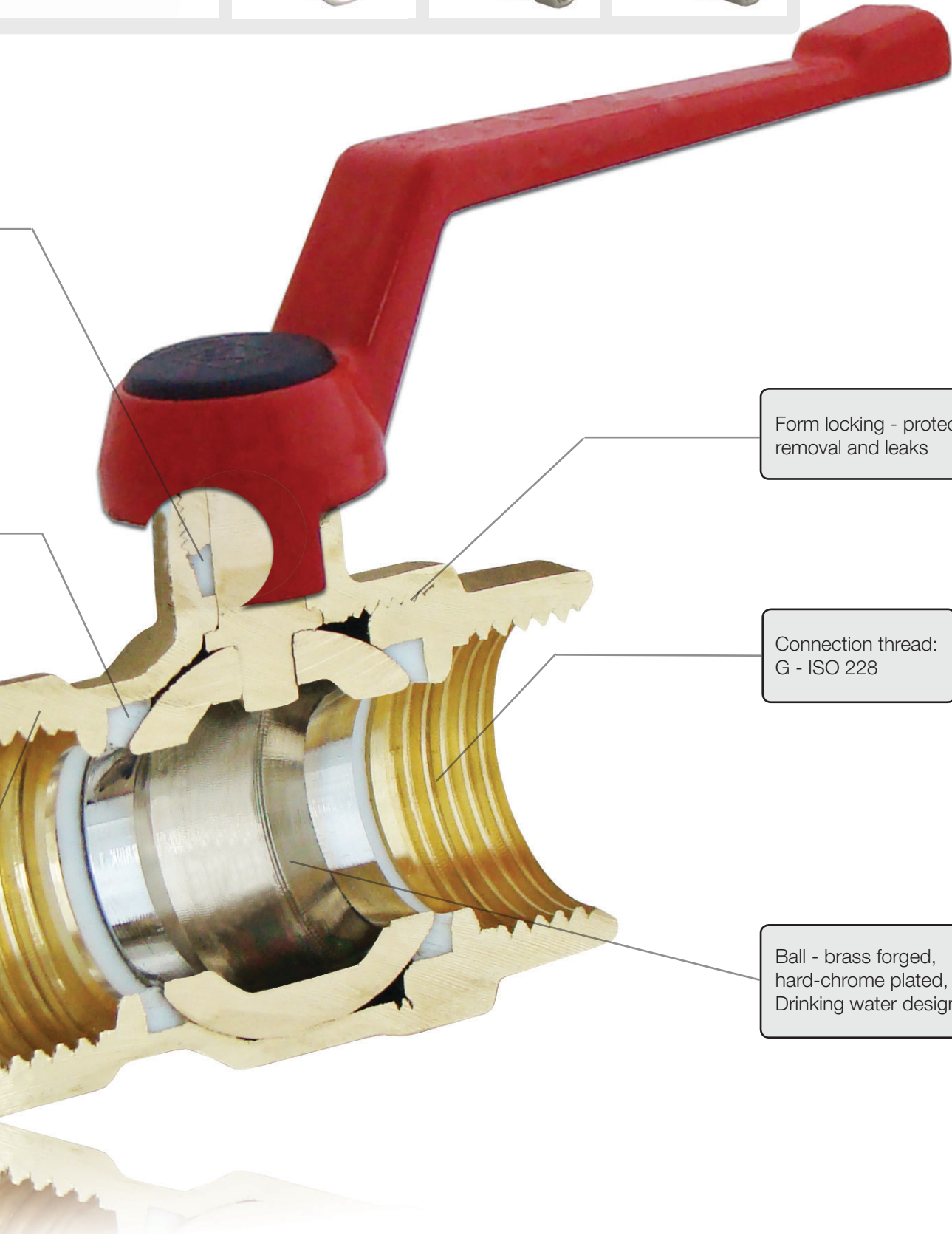

Form locking - protection against removal and leaks

Connection thread:
G - ISO 228

Ball - brass forged,
hard-chrome plated, hollow.
Drinking water design, cavity-free.

TECHNICAL DATA

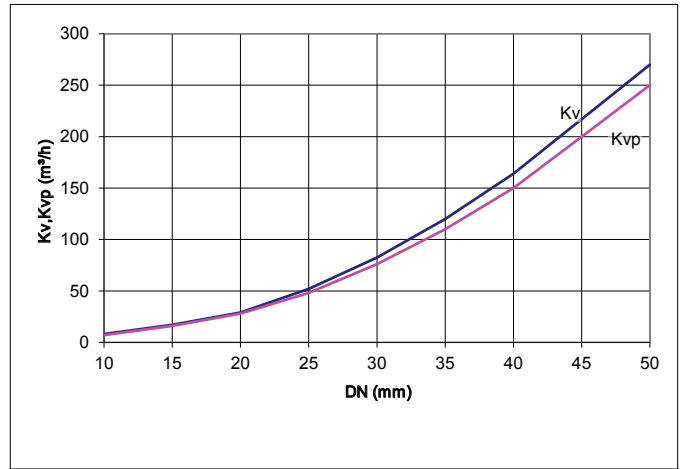
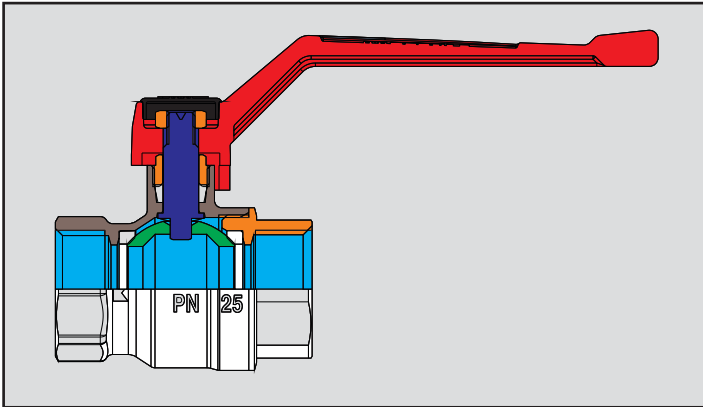

TECHNICAL DATA:

- Dimensions: DN8 - DN80
- Connection thread
ISO 228
ISO 7 / 1
- Straight model
- Operating pressure PN 63 - 16
- Operating temperature
30°C - 120°C (water: 0.5°C - 110°C - except for steam)
- Medium: water, compressed air and all non-aggressive media

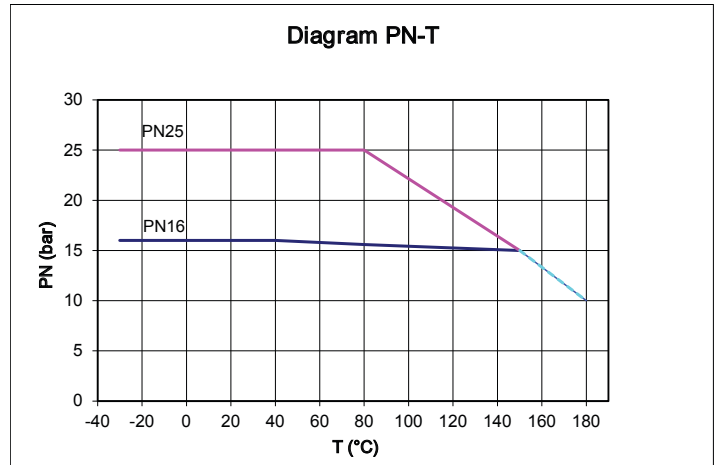

DN	15	20	25	32	40	50
Kv	17	34	55	102	165	270
Kvp	15,8	31,5	51	95	153	250

Kv: Rate of flow unit (m³/h) - water at 15.5°C, pressure drop 1 bar (100kPa) when valve fully opened.

Kvp: Rate of flow unit (m³/h) - density of air 1.15 kg/m³ at 15.4°C, 1 mbar pressure loss (0.1 kPa) when valve fully opened.

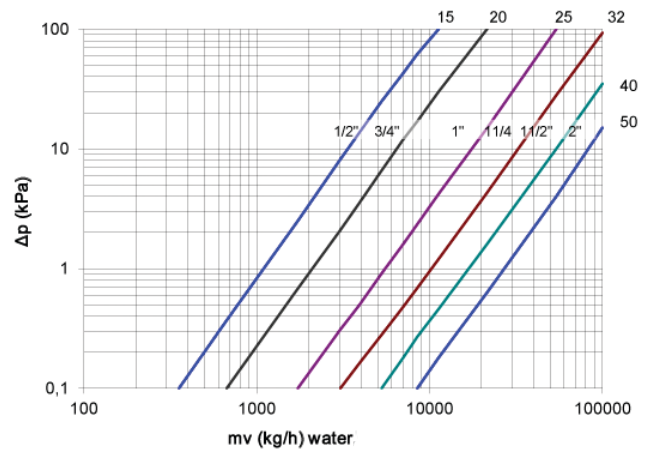

Of course, we don't just make "one" ball valve. Herz have developed different versions and models to suit a diverse range of applications for our customers. Whether for technical gases, such as nitrogen or natural gas, coolant or drinking water, HERZ can offer not only a product complying with the relevant standards but also non-conforming products for practically every medium.

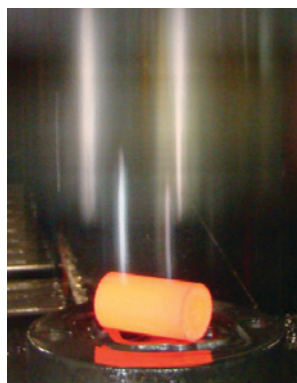
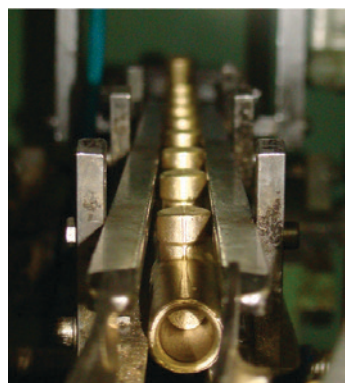

HERZ BALL VALVE MODEL **2201**: models DN 15 (1/2") to DN 50 (2"), pressure class 25 bar; water, oil, recommended for heating systems. Tee shaped handles, connections on both sides, internal thread in accordance with ISO 7, brass body nickel-plated, colour of handle black. Cover in red or blue, some models with thermometer. Insulating shell **4096** from EPP (expanded polypropylene), colour anthracite / black or silver gray.



HERZ BALL VALVE MODEL **2201**: models DN 15 (1/2") to DN 50 (2"), pressure class 25 bar; water, oil, recommended for heating systems. Handles in lever or wing shape, connections on both sides, internal thread in accordance with ISO 7, brass body nickel-plated, colour of handle red.



HERZ BALL VALVE MODEL **2206**: models DN 15 (1/2") to DN 50 (2"), pressure class PN 25 bar; water, recommended for sanitary installations. Handles in lever or wing shape, connections on both sides, internal thread in accordance with ISO 7, brass body made from dezincification resistant brass, bright, colour of handle red. Insulating shell **4096** from EPP (expanded polypropylene), colour anthracite / black or silver gray.



HERZ BALL VALVE MODEL **2211**: models DN 15 (1/2") to DN 50 (2"), pressure class 25 bar; water, oil, recommended for heating systems. Handles in lever or wing shape, connections on both sides, internal thread in accordance with ISO 7, brass body nickel-plated, colour of handle red.



HERZ BALL VALVE MODEL **2216**: models DN 15 (1/2") to DN 50 (2"), pressure class PN 25 bar; water, recommended for sanitary installations. Handles in lever or wing shape, connections on both sides, internal-external thread in accordance with ISO 7, brass body made from dezincification resistant brass, bright, colour of handle red.



HERZ BALL VALVE MODEL **2206**: models DN 15 (1/2") to DN 50 (2"), pressure class PN 25 bar; water, recommended for sanitary installations. Tee shaped handles, connections on both sides, internal thread in accordance with ISO 7, brass body made from dezincification resistant brass, bright, colour of handle black. Cover in red or blue, some models with thermometer. Insulating shell **4096** from EPP (expanded polypropylene), colour anthracite / black or silver gray.



2206



2206

HERZ BALL VALVE MODEL **2100**: models DN 8 (1/4") to DN 80 (3"), pressure classes from 16 to 63 bar according to dimensions; water, recommended for heating systems. Handles in lever or wing shape, connections on both sides, internal thread or internal-external thread in accordance with ISO 7, brass body nickel-plated, colour of handle red. Insulating shell **4096** from EPP (expanded polypropylene), colour anthracite / black or silver gray.

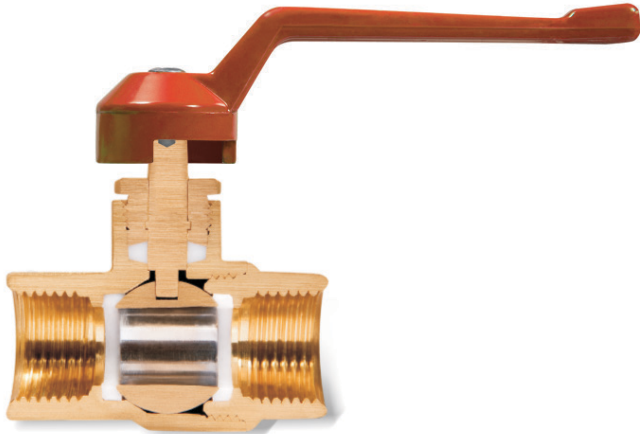

2100

VARIANT WITH DRAINING (**2402**): models DN 15 (1/2") to DN 40 (1 1/2"), pressure classes from 25 to 40 bar according to dimensions; water, recommended for heating systems. Handles in lever or wing shape, connections on both sides, internal thread in accordance with ISO 7, brass body nickel-plated, colour of handle red.



2402

MODEL VARIANT PIPEFIX WITH PRESS CONNECTION (P72) for pipe dimensions 16 x 2.0, 18 x 2.0, 20 x 2.0, 26 x 3.0, PN 10, water, heating and cooling systems, special bright brass, colour of handle red.



P7216

MODEL VARIANT PIPEFIX WITH PRESS CONNECTION FOR FLUSH MOUNTING (P72) for pipe dimensions 16 x 2.0, 20 x 2.0, 26 x 3.0, PN 10, water and sanitary installations, special bright brass.



P7216

HERZ BALL VALVE MODEL **2100 W**: models DN 15 (1/2") to DN 50 (2"), pressure class PN 16 bar; water, recommended for sanitary installations, straight-through body with water flushed ball free of dead space to avoid the growth of legionella in compliance with German Specialist Association for Gas and Water (DVGW) guideline. Handle in lever or wing shape, connections on both sides, internal thread in accordance with ISO 7, brass body made from dezincification resistant special brass, bright, colour of handle green.

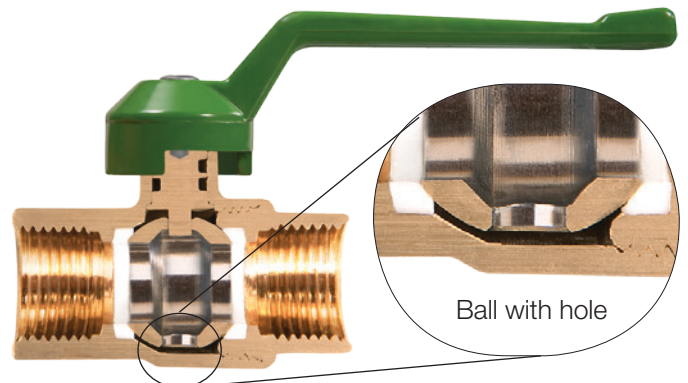

2100

MULTIFUNCTION BALL VALVE: DN 20 (3/4") to DN 32 (1 1/4"), pressure class PN 25, water and water-glycol mixture, recommended for heating and cooling systems, 4-way ball valve specially suitable for technically correct filling, flushing and draining from domestic installations, ball 360° rotatable, additional device connection or pulse generator possible, brass body made from dezincification resistant special brass, nickel-plated, medium temperature display on handwheel, colour of handle red and blue.

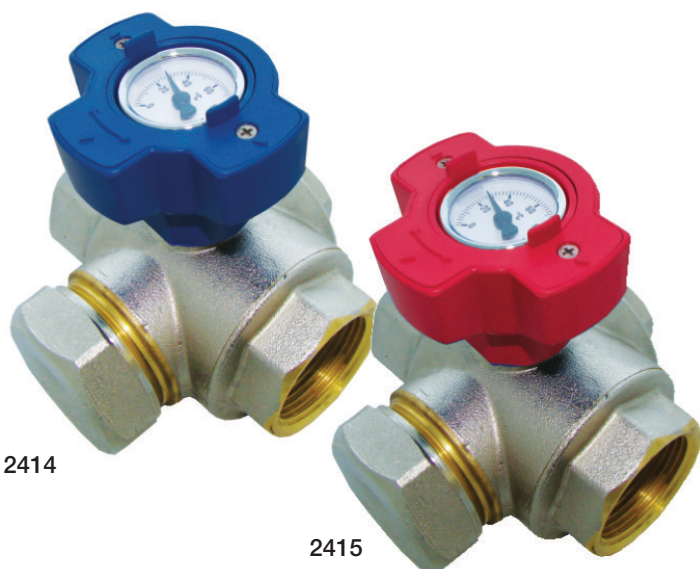

2414

2415

MODEL VARIANT WITH INTEGRATED BACKFLOW PREVENTER (2110)

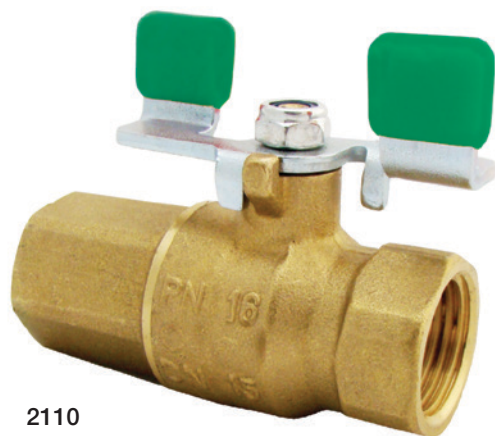

2110

HERZ BALL VALVE MODEL (2304, 2305); Models DN 10 (3/8") to DN 50 (2"), pressure class PN 4 bar, for technical gases and gas installations in compliance with DIN DVGW G260, operating temperature -20°C to +60°C, steel handles in lever or wing shape, connections on both sides with internal thread or on one side with external thread in accordance with ISO 7, brass body nickel-plated, standard colour of handles yellow.

HERZ BALL VALVE MODEL (2300, 2301); DN 8 (1/4") to DN 50 (2"), pressure class PN 1 bar, for technical gases and gas installations in compliance with DIN DVGW G260 and EN 331, operating temperature -20°C to +60°C, steel handles in lever or wing shape, connections on both sides with internal thread or on one side with external thread in accordance with ISO 7, bright brass body, standard colour of handles yellow. High-temperature resistant model, in the event of fire, the sealing locks the ball valve for a period of 30 minutes. Model with TAS (thermic armature safety) (2303, 2362); at ca. 100°C the ball valve is automatically closed by means of a thermic element and will sustain a temperature of 925°C for a period of 60 minutes.



2302/ 2362

HERZ BALL VALVE MODEL (2300); DN 8 (1/4") to DN 50 (2"), pressure class PN 1 bar, for technical gases and gas installations in compliance with DIN DVGW G260, Austrian Specialist Association for Gas and Water (ÖVGW) and EN 331, operating temperature -20°C to +60°C, steel handles in lever or wing shape, connections on both sides with internal thread in accordance with ISO 7, brass body bright, standard colour of handles yellow.

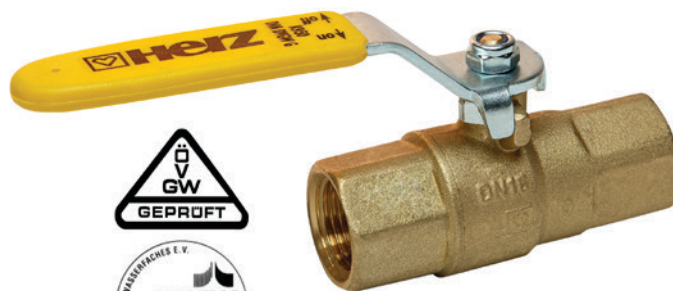

2300

CONTROL VALVE 2117 for modulating control of heating, cooling or air systems, female thread, PN 25 and PN 40. Actuators 7712 to be ordered separately. Operating pressure 25 and 40 bar, model DN 15 to DN 50. Ball with equal percentage characteristic. Spindle with large sliding surface and Teflon-slip ring.



2117



HERZ Valves UK

Progress House, Moorfield Point
Moorfield Road, Slyfield Industrial Estate
Guildford, Surrey GU1 1RU
Telephone: 01483 502211 Fax: 01483 502025
E-Mail: sales@herzvalves.com
www.herzvalves.com

International Headquarter

HERZ Armaturen GmbH

Richard-Strauss-Str. 22, A-1230 Vienna
Tel.: +43 (0)1 616 26 31-0, Fax: +43 (0)1 616 26 31-27
E-Mail: office@herz.eu

www.herz.eu

