

F615 / F625 / F629

Fully-lugged gearbox operated
Butterfly Valves



F625
50-300mm **PN16**

Features & Benefits

- Aluminium Bronze disc
- Stainless steel shaft
- Gearbox operated
- Valves are suitable for use with flanges conforming to BS EN 1092-2 PN10 or PN16 - Sizes 65-200mm
- BS EN 1092-2 PN16 flanges only - Sizes 250-600mm PN16 only
- F625 sizes 50-300mm are WRAS approved

Materials

PART	MATERIAL
Body	Ductile Iron ASTM A536 (Epoxy Paint)
Disc	Aluminium Bronze
Liner (F615)	Nitrile Temp. -10 to 90°C
Liner (F625)	EPDM (WRAS Approved) Temp. -10 to 100°C (80°C WRAS)
Liner (F629)	EPDM (High Temperature) Temp. -10 to 130°C
Shaft	Stainless Steel Type 410
Taper Pin	Stainless Steel Type 316
Key	Carbon Steel
O-Ring	Buna-N
Bushing	PTFE

Dimensions & Weights

SIZE (mm)	WEIGHT (kg)	A (mm)	B (mm)	C (mm)	D (mm)	E (mm)	F (mm)	G (mm)	H (mm)	J (mm)	K (mm)
50	15.5	162	80	42	40	102	150	53	45	54	158
65	16	175	83	45	40	121	150	64	45	54	158
80	18.7	181	95	45	40	130	150	79	45	54	158
100	24.1	200	114	52	40	171	150	104	45	54	158
125	25	213	127	54	40	197	200	123	45	54	148
150	26.4	225	140	56	40	219	200	156	45	54	148
200	36.7	260	175	61	38	268	300	203	78	81	226
250	47.1	292	203	66	38	332	300	251	78	81	226
300	62.1	337	242	77	38	410	300	302	78	81	226
350	84.9	368	279	76	38	432	300	334	78	81	226
400	123.8	400	305	86	57	448	450	350	120	130	277
450	139.7	422	381	105	57	546	450	441	120	130	277
500	215.5	479	394	130	63	592	450	490	185	160	320
600	337.3	562	457	151	63	708	450	597	185	160	320



Dimensional Drawing

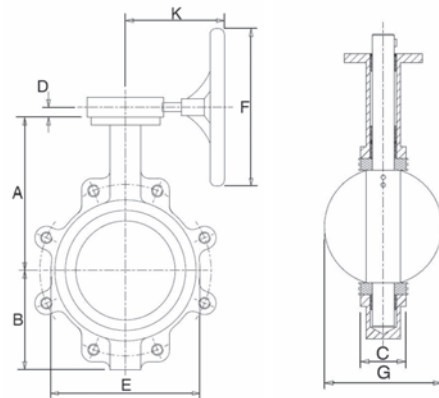

Pressure/Temperature Ratings

	F615	F625	F629
TEMPERATURE (°C)	-10 to 90	-10 to 100	-10 to 130
PRESSURE (BAR)	16	16	16

Intermediate pressure ratings shall be determined by interpolation.

WRAS approved -10 to 80°C

PRESSURE RATING: PN16
END CONNECTION: Lugged
OPERATOR: Gearbox

SPECIFICATION: Conforms to: BS EN 593: 2009

F615 - Suitable for Group 1 and 2 gases and Group 1 and 2 liquids as defined by the Pressure Equipment Directive 97/23/EC*

F625 - Suitable for Group 2 liquids only as defined by the Pressure Equipment Directive 97/23/EC* and these valves are WRAS approved.

F629 - Suitable for Group 2 liquids only as defined by the Pressure Equipment Directive 97/23/EC.*

* See page 251 for more information

Every effort has been made to ensure that the information contained in this publication is accurate at the time of publishing. Crane Ltd assumes no responsibility or liability for typographical errors or omissions or for any misinterpretation of the information within the publication and reserves the right to change without notice.