

HERZ Actuating drive

Data sheet for **7711**, Issue **0713**

☑ Dimensions in mm

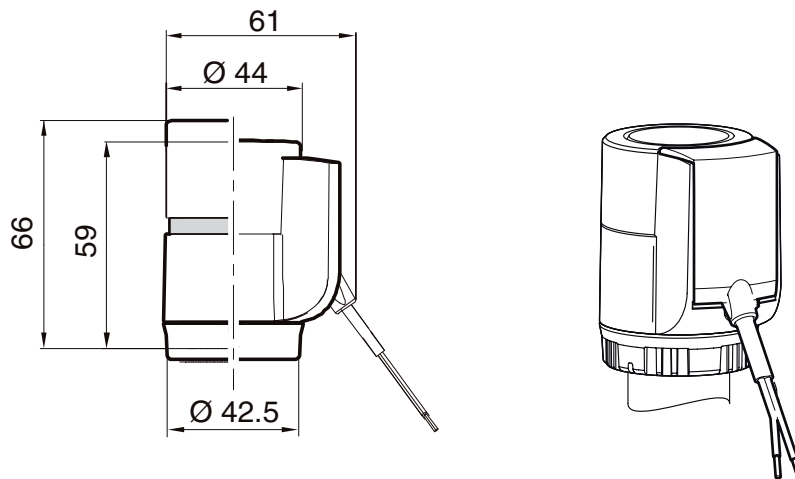

☑ Models

- 1 **7711 01** **HERZ Actuating drive M28 x 1.5, 230 V, 50 Hz**
normally closed, closing force 90 N, operating voltage 230 V ~, threaded connection M28 x 1.5, max. stroke 4.5 mm, elevated version for installation on **8531, 8532**
- 1 **7711 10** **HERZ Actuating drive M28 x 1.5, 230 V, 50 Hz**
normally closed, closing force 115 N, operating voltage 230 V ~, threaded connection M28 x 1.5, max. stroke 4.5 mm
- 1 **7711 11** **HERZ Actuating drive M28 x 1.5, 230 V, 50 Hz**
normally open, closing force 110 N, operating voltage 230 V ~, threaded connection M28 x 1.5, max. stroke 4.5 mm
- 1 **7711 12** **HERZ Actuating drive M28 x 1.5, 24 V, AC/DC**
normally closed, closing force 115 N, operating voltage 24 V ~, threaded connection M28 x 1.5, max. stroke 4.5 mm
- 1 **7711 13** **HERZ Actuating drive M28 x 1.5, 24 V, AC/DC**
normally open, closing force 110 N, operating voltage 24 V ~, threaded connection M28 x 1.5, max. stroke 4.5 mm
- 1 **7711 20** **HERZ Actuating drive M30 x 1.5, 230 V, 50 Hz**
normally closed, closing force 115 N, operating voltage 230 V ~, threaded connection M30 x 1.5, max. stroke 4.5 mm
- 1 **7711 21** **HERZ Actuating drive M30 x 1.5, 230 V, 50 Hz**
normally open, closing force 110 N, operating voltage 230 V ~, threaded connection M30 x 1.5, max. stroke 4.5 mm
- 1 **7711 22** **HERZ Actuating drive M30 x 1.5, 24 V, AC/DC**
normally closed, closing force 115 N, operating voltage 24 V ~, threaded connection M30 x 1.5, max. stroke 4.5 mm
- 1 **7711 23** **HERZ Actuating drive M30 x 1.5, 24 V, AC/DC**
normally open, closing force 110 N, operating voltage 24 V ~, threaded connection M30 x 1.5, max. stroke 4.5 mm

Application

The HERZ actuating drive is an electrothermal actuator for 2-point control in heating and cooling systems that is installed in combination with a temperature controller. Exceptionally well suited for zone control and floor heating. The HERZ actuating drive can be combined with all HERZ valves with connection threads M28 x 1.5 or M30 x 1.5 that are configured for thermostatic operation. The version with auxiliary contact additionally enables signaling of the switch position or to switch another electrical device. At direct voltage of 4...30 V the switching capacity is 1...100 mA, 1 A, 48 V=.

The electric circuits at the auxiliary contact and at the drive must have the same phase. It is not permissible to apply 400 V ~ to the 4 x 0,5 mm² cable. It is not permissible to connect this cable to differing circuits such as extra-low voltage or low voltage circuits.

The actuating cam in the drive must be engaged before mounting the connector plug. This actuating cam can no longer be removed. However, it is still possible to subsequently mount a 2-point connector plug if necessary.

Accessory for drive version NC (normally closed):

When the drive opens, the internal contact closes. If a normally closed contact is required, the accessory auxiliary contact can be used as "normally open". The contact opens when the drive opens.

Accessory for drive version NO (normally open):

When the drive lowers, the internal contact closes. If a normally closed contact is required, the accessory auxiliary contact can be used as "normally closed". The contact opens when the drive lowers.

Operation

The actuating drive is switched on via an electrical contact, e.g. from a room thermostat, and starts opening or closing the thermostatic valve. The actuating movement is accomplished by an electrically-heated expansion element. When the heating current is switched off, the valve closes or opens respectively. The HERZ actuating drive is maintenance-free and offers silent operation.

Emergency function

With factory setting "normally closed" the valve can be opened by removing the drive in case of a power failure.

Special design features

The actuator is mounted on a plastic console and provided with a cover made of self-extinguishing plastic. Colour pure white RAL 9010. Connection to valve via plastic bayonet coupling.

Installation

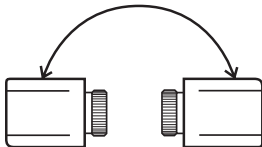

Switch off voltage supply prior to working on the device.

- The connection must only be established by authorized personnel.
 - The connection is to be established as per the attached simplified diagram.
 - The device is exclusively designed for connection to permanently installed cables in closed, dry rooms.
 - Care must be taken during installation to avoid contact between cables carrying mains voltage such as the mains supply line or relay connection lines on the one hand and cables carrying low-voltage such as sensor leads on the other hand (minimum distance 4 mm with basic-isolated conductors).
 - The connection lines must be protected against loosening by themselves as per the requirements of EN 60730, part 1.
- VDE 0100 and EN 60730, part 1 as well as the regulations of the local energy supply company must be complied with.
 - Should you encounter a functional problem with the device, please first check for correct connection and voltage supply.
 - Wrong connections can damage the control device! We decline all responsibility for damage resulting from wrong connection and/or inappropriate handling!

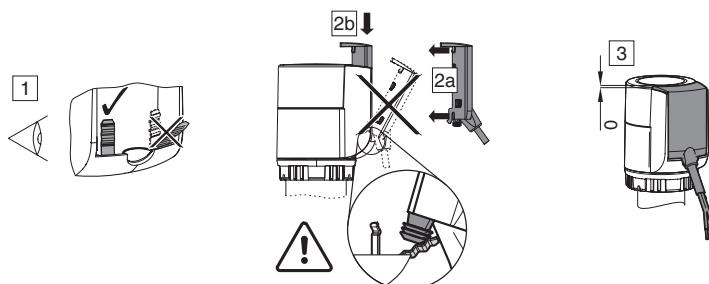

☑ Installing the thermostatic valve

The flow direction must match the arrow on the valve body.

☑ Installing the actuating drive

First screw bayonet nut on valve and tighten with 2 Nm. Then loosely place the drive on the valve. Three recesses on the drive ring indicate the matching installation position with reference to the three ribs on the bayonet nut. Turn the bayonet ring clockwise by 90° up to the first "click": the valve cone is now pretensioned. When reaching the second "click", the drive is fully functional. This position also corresponds to the safety position, protecting against loosening by vibration.

When turning the bayonet ring, the drive automatically adapts to the valve's closing dimension.

To ensure perfect operation with drive version NO, the force of the pressure spring in the valve must be $F_v \geq 30 \text{ N}$. In addition, the NO version should only be removed from the valve when cooled down.

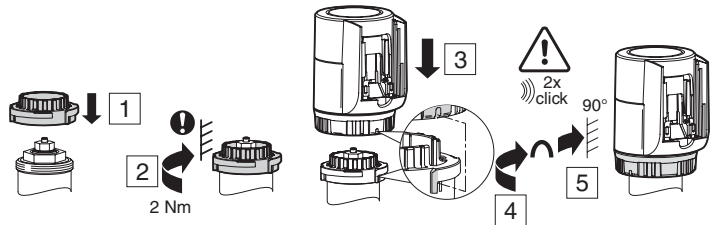

☑ Position indicator

The cover serves as largest possible position indicator. It can be clearly seen from all directions and can also be felt in the dark.

With version "normally closed", the cover lifts off and the gray lift element becomes visible. At full stroke, the cover stands off the connector plug upper edge up to a maximum of 5 mm.

With the "normally open" version, the cover lowers until it is at the same height as the connector plug upper edge: The gray lift element is no more visible.

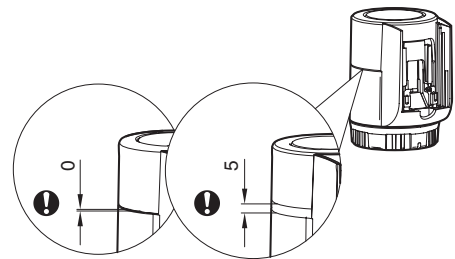

☑ Technical data

Order number	Voltage	Closing force (N)	NC / NO	Connection thread	min. runtime (min)	Weight (kg)
1 7711 01	230 V	90	NC	M28 x 1.5	3.5	0.18
1 7711 10	230 V	115	NC	M28 x 1.5	3.5	0.18
1 7711 11	230 V	110	NO	M28 x 1.5	3.5	0.18
1 7711 12	24 V	115	NC	M28 x 1.5	4.5	0.18
1 7711 13	24 V	110	NO	M28 x 1.5	4.5	0.18
1 7711 20	230 V	115	NC	M30 x 1.5	3.5	0.18
1 7711 21	230 V	110	NO	M30 x 1.5	3.5	0.18
1 7711 22	24 V	115	NC	M30 x 1.5	4.5	0.18
1 7711 23	24 V	110	NO	M30 x 1.5	4.5	0.18

Supply voltage	230 V ~; 50 ... 60 Hz	24 V ~; 50 ... 60 Hz
Power consumption during operation	2 W	2 W
Switch-on capacity	approx. 40 W / 40 VA	5 W / 5 VA
Inrush current	250 mA	250 mA
Max. operating temperature	100 °C	
Operating temperature	0 °C to 50 °C	
Storage and transport temperature	-25 °C to 70°C	
Humidity	< 85 % rF, non-condensing	
Protection class	IP 54 (EN 60730-1, -2, -14)	
Protection class 230 V	II (EN 60730-1)	
Protection class 24 V	III (EN 60730-1)	
Cable length	1 m	

Room thermostat

Standard room thermostats equipped with a thermal feedback loop can be used for piloting the HERZ actuating drive. If required, several drives can be connected in parallel taking the maximum admissible electrical load of the switch contact into account.

Design and planning notes

When selecting the switch contacts and mains fuses, the inrush current of the heating element must be taken account of. The voltage loss in the electric lines must not exceed 10 %, ensuring that the indicated runtime is guaranteed.

Max. cable length for an actuating drive with given cable cross-sections (information with voltage drop approx. 5 %; at 230 V voltage drop is 10 V, at 24 V voltage drop is 1 V).

When using several actuating drives, the indicated cable length must be divided by the number of actuating drives connected.

Cable cross-section (mm ²)	230 V, max. length (m)	24 V, max. length (m)
2 x 0.75	1500	168
2 x 1.0	2000	224
2 x 1.5	3000	340
2 x 2.5	5000	560

Resistance values

Please refer to the HERZ standard diagrams contained in the relevant standard sheets with regard to resistance values when operating HERZ valves with HERZ actuating drives. The curves "Valve fully open" or "max." apply.

1 7796 04 HERZ Transformer 230/24 V

The overload-proof HERZ safety transformer 230/24 V is designed for the connection of HERZ room thermostats and HERZ actuating drives and suitable for operation of 8 HERZ actuating drives max.

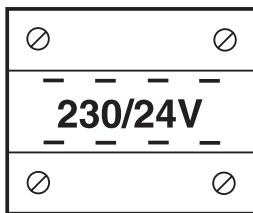

Version	as per VDE 0551
Protection class	II
Protection class	IP 20
ISO Cl.	T40/E
Input voltage	230 V
Fuse in input circuit	50-60 Hz, 315 mA
Output voltage	24 V
Power	50 VA
Quick installation on device rail	ref. DIN 42227/3
Dimensions	106 x 90 x 74 mm (B x H x T)

1 7791 23 HERZ Electronic room temperature controller for 2-point or pulse control with timer

For individual control with programmable times and temperatures. Timer with weekly and annual programs, automatic switchover from summer to winter time.

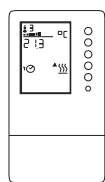

Setpoint range	8 – 38 °C
Switching differential as 2-point controller	0.4 – 8 K
Measurement accuracy	0.3 K at 20 °C
Operating voltage	230 V

1 7790 15 HERZ Electronic room temperature controller for 2-point control

1 switchover contact	
Setpoint range	10 – 30 °C
Switching differential	+/-0.2 K fixed
Operating voltage	230 V

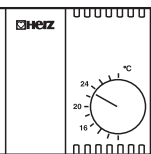

1 7790 25 HERZ Electronic room temperature controller for 2-point control

- 1 switchover contact
- Setpoint range 10 – 30 °C
- Switching differential +/-0.2 K fixed
- Operating voltage 24 V

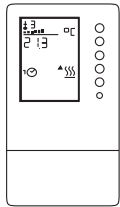

1 7794 23 HERZ Electronic climate controller with PI behavior

For heating and cooling operation, with programmable time and temperature settings. Outputs for actuating drive (3-point) and thermal drive and for one pump or fan (ON/OFF signal)
 Fixed basic program (factory setting) for initial commissioning, easy adaptation to the system by selecting of one out of 8 basic control modules via service parameters.
 Housing can be plugged onto electronics, white (RAL 9010), front with keypad and digital displays in viewing window. Timer with weekly and annual programs, relay with operating hours counter.
 For wall mounting or mounting onto in-wall socket.

Connection plan

HERZ Actuating drive

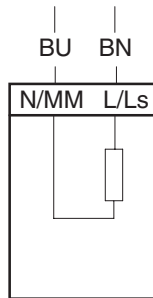

HERZ Actuating drive with auxiliary contact

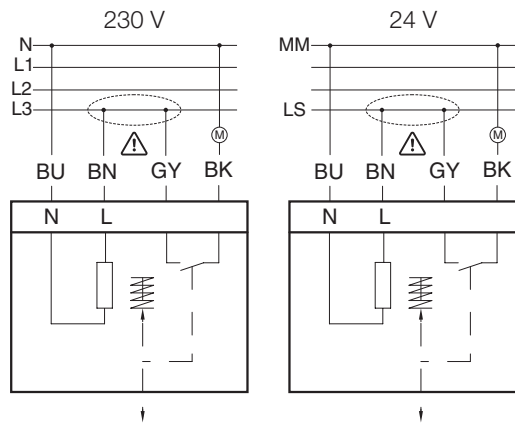

BU	BN	BK	GY
blue	brown	black	gray

Accessories

- 1 **7711 24** Auxiliary contact for actuating drive NC, 230 V, 5 (2) A
cable length 2 m, dimension 0.5 x 4
- 1 **7711 34** Auxiliary contact for actuating drive NO, 230 V, 5 (2) A
cable length 2 m, dimension 0.5 x 4
- 1 **7711 25** Connector plug 0 – 10 V for HERZ actuating drives, NC
Using this connector plug, the drive can also be used for modular control.
- 1 **7711 35** Connector plug 0 – 10 V for HERZ actuating drives, NO
Using this connector plug, the drive can also be used for modular control.
- 1 **7711 26** Adapter, high version, to be mounted on valves with connection thread M30 x 1.5
drive dimensions +5 mm
closing dimension 4.5 – 18.5 mm (NC) and 8.5 – 22.5 mm (NO)
- 1 **7711 27** Adapter, high version, to be mounted on valves with connection thread M28 x 1.5
drive dimensions +5 mm
closing dimension 4.5 – 18.5 mm (NC) and 8.5 – 22.5 mm (NO)

Note: All diagrams are for illustrating purposes only and do not claim to be complete.

All information contained in this brochure corresponds to the state of knowledge at the time of going to print and is intended for informational purposes only. We therefore reserve the right to make any changes subject to advancing technology. The images are symbolic representations only and can therefore visually deviate from the actual appearance of products. Any deviations in color are due to typography. Subject to country-specific product variants. We reserve the right to change specifications and functions without notice. Please contact your nearest HERZ subsidiary if you have any questions.